



YOUR DIVIDER

YOUR DIVIDER

Nel 2009 abbiamo ideato e creato una linea di macchine dal design pulito e inconfondibile che ci ha distinto da tutti; da quei primi successi nasce una nuova generazione di spezzatrici uniche non solo nel design ma nell'intera concezione. Nessun dettaglio è stato lasciato al caso, ogni aspetto è stato curato per darvi un prodotto tutto nuovo, più affidabile, più sicuro e più piacevole da utilizzare.

In 2009, we designed and built a line of dough handling machines that featured a groundbreaking clean and unmistakable design; from those early successes has risen a new generation of dough dividers, unique not only in design but concept. No detail was left to chance, every facet has been taken into consideration in order to give you a reliable, safe and visually pleasing tool for achieving excellent results.

Im Jahr 2009 haben wir eine Maschinenserie mit einem klaren und unverwechselbaren Design entwickelt und gebaut, mit der wir uns von allen anderen unterscheiden. Aus diesen ersten Erfolgen ist eine neue Generation von Teigteilern hervorgegangen, die nicht nur in Sachen Design, sondern auch vom Gesamtkonzept her einzigartig sind. Kein Detail ist dem Zufall überlassen worden, jeder Aspekt wurde so durchleuchtet, dass wir Ihnen ein ganz neues, zuverlässigeres, sichereres und bedienungsfreundlicheres Produkt zur Verfügung stellen können.

En 2009 nous avons pensé et créé une ligne de machines au design sobre et reconnaissable qui nous a distingué de tous; de ces premiers succès est née une nouvelle génération de diviseuses uniques non seulement dans leur design mais aussi dans leur conception tout entière. Aucun détail n'a été laissé au hasard, chaque aspect a été soigné pour vous offrir un produit complètement nouveau, plus fiable, plus sûr et plus agréable à utiliser.

En 2009 ideamos y creamos una línea de máquinas con un diseño sencillo e inconfundible que nos distingue de los otros; de aquellos primeros éxitos nace una nueva generación de porcionadoras únicas, no solo por su diseño sino por toda su concepción. No se ha dejado de lado ningún detalle, se han cuidado todos los aspectos para ofrecer un producto completamente nuevo, más seguro y de utilización más agradable.

В 2009 году мы разработали и создали серию машин, отличающуюся чистым и характерным дизайном, выделяющуюся на фоне других предложений; с этих первых успехов начинается история нового поколения тестоделительных машин, уникальных не только с точки зрения дизайна, но и общей концепции. Ни одна деталь не была оставлена без внимания, каждый аспект был проработан, чтобы предложить полностью новый продукт – более надежный, безопасный и приятный в использовании.





vitella

13 SPEZZATRICI ARROTONDATRICI
bun rounding dividers

18 SPEZZATRICI E PRESSE
dividers and press

24 ACCESSORI E OPTIONAL
accessories and optionals

32 DIMENSIONI E PESI
dimensions and weights

33 INFORMAZIONI GENERALI
general information



3.0

P 1

6.5



1.8



SEMPRE LO STESSO
UTILIZZO, MA PIÙ BELLO.

Always reliable, more handsome than ever.



5.0

P2

3.0



PICCOLI ACCORGIMENTI CHE FANNO LA DIFFERENZA.

Details that make the difference.

Abbiamo studiato a fondo il vostro lavoro per portarvi soluzioni semplici e pratiche. Per questo è stato curato ogni millimetro della macchina, dentro e fuori, perchè sia perfetta per voi: perfetta nella facilità di utilizzo, nell'assemblaggio, nel tipo di materiali scelti, nella sicurezza e nella velocità di pulizia.

We have thoroughly studied the workflow of pastry and bread makers of all sizes, to bring you simple and practical solutions. Every millimeter of the dough dividers has been planned, inside and out, to bring you perfection: perfect in the ease of use, materials and finishes, assembly and disassembly operations, safety features and ease of cleaning.

Wir haben uns eingehend mit Ihrer Arbeit befasst, um Sie mit einfachen und praktischen Lösungen zu unterstützen. Deshalb haben wir jeden Millimeter der Maschine, innen und außen, so gestaltet, dass er für Sie perfekt ist: perfekt in Sachen Bedienungsfreundlichkeit, Zusammenbau, Materialauswahl, Sicherheit und Reinigungsgeschwindigkeit.

Nous avons étudié votre travail en profondeur pour vous offrir des solutions simples et pratiques. C'est pourquoi chaque millimètre de la machine a été soigné, dedans et dehors, pour qu'elle soit parfaite pour vous: parfaite dans la facilité d'utilisation, dans l'assemblage, dans le type de matériaux choisis, dans la sécurité et dans la rapidité de nettoyage.

Hemos estudiado a fondo su trabajo para ofrecer soluciones sencillas y prácticas. Por ello se ha cuidado al milímetro la máquina, dentro y fuera, para que sea perfecta para usted: perfecta por la facilidad de utilización, el montaje, el tipo de materiales elegidos, la seguridad y la velocidad de limpieza.

Мы досконально изучили вашу работу, чтобы предложить простые и практичные решения. Именно с этой целью создавался каждый миллиметр машины, как снаружи, так и внутри, чтобы она идеально подходила для ваших нужд: идеальная благодаря простоте использования, сборке, типу выбранных материалов, безопасности и скорости очистки.



LA SICUREZZA È SEMPRE AL PRIMO POSTO.

Safety is always our top priority.

È un argomento dove non si ammettono compromessi: lavorare con serenità non ha prezzo. Ecco nuovi sistemi che valorizzano ulteriormente le nostre macchine, studiati per evitare pericoli nelle operazioni quotidiane, senza intralciare o rallentare il lavoro stesso.

Is a matter which does not allow compromises nor shortcuts: peace of mind while being hard at work is priceless. Here are new safety features from Vitella that further enhance the overall performance our machines. They are designed to prevent hazards in daily operations, without hindering nor slowing down the work itself.

Ein Thema, das keine Kompromisse zulässt: Entspannt zu arbeiten ist von unschätzbarem Wert. In diesem Sinne sind die wertsteigernden neuen Systeme unserer Maschinen konzipiert, die Gefahren bei der täglichen Arbeit vermeiden sollen, ohne die Arbeit selbst zu behindern oder zu verlangsamen.

C'est un sujet qui n'admet pas de compromis: travailler avec sérénité, ça n'a pas de prix. Voici de nouveaux systèmes qui valorisent ultérieurement nos machines, étudiés pour éviter les dangers dans les opérations quotidiennes, sans entraver ou ralentir le travail.

Es un tema en el que no se admiten medias tintas: trabajar con serenidad no tiene precio. Los nuevos sistemas ofrecen un ulterior valor añadido con las máquinas, se han estudiado para evitar peligros en las operaciones diarias, sin poner trabas ni ralentizar el trabajo mismo.

Это область, не терпящая компромиссов: у безмятежной работы нет цены. Новые системы, которые еще больше повышают ценность нашего оборудования, позволяют предотвратить опасные ситуации при выполнении повседневных задач, не мешая и не замедляя работу.





30 P1
6.5
1.8

FORMA PERFETTA.

Perfect shape.

Le spezzatrici arrotondatrici sono delle macchine che permettono di tagliare un pezzo di pasta cruda, in piccole parti, e successivamente grazie ad un piatto oscillante di arrotondare ogni singolo pezzo, in modo da ottenere delle palline di peso e forma uguale, tutto questo in pochi secondi.

Bun rounding dividers are machines that cut a piece of raw dough into small portions and, using an oscillating plate, subsequently roll each piece to obtain balls of the same weight and shape, all in a few seconds.

Die Teigteil- und Wirkmaschine sind Maschinen zum Teilen eines rohen Teigballens in kleine Stücke, die anschließend von einem schwingenden Teller gewirkt werden, so dass Teilkugeln gleicher Größe und gleichen Gewichts erhalten werden, und zwar in wenigen Sekunden

Les diviseuses bouleuses sont des machines qui permettent de couper un morceau de pâte crue en petites parties, puis, grâce à un plateau oscillant, d'arrondir les pâtons, de manière à obtenir des boules de poids et forme identiques, le tout en quelques secondes.

Las divisoras boleadoras son máquinas que permiten cortar un trozo de masa cruda en piezas más pequeñas y sucesivamente, gracias a un plato oscilante, redondear cada una de las piezas hasta obtener bolas de igual forma y peso en unos segundos

Тестоделители-округлители агрегаты, позволяющие разрезать кусок сырого теста на небольшие порции и затем благодаря качающемуся лотку сворачивать каждый отдельный кусочек для формирования шариков равного веса и формы – за несколько секунд.



SPEZZATRICI ARROTONDATRICI AUTOMATICHE

*Automatic bun
rounding dividers*
*Diviseuses bouleuse
automatiques*
*Teigteil- und Wirkmaschine
automatisch*
*Divisoras boleadoras
automáticas*
*Тестоделители-округлители
Автоматические*

| divisioni /divisions | grammatura /weight min | grammatura /weight max | capacità vasca / basin capacity | ø testata / head diamete | capacità oraria / hourly capacity |
|-------------------------|---------------------------|---------------------------|------------------------------------|-----------------------------|--------------------------------------|
| | gr | gr | kg | mm | pz./h |
| 11 | 180 | 500 | 5,5 | 400 | 1300 |
| 15 | 150 | 360 | 5,5 | 400 | 1800 |
| 18 | 120 | 280 | 5 | 400 | 2100 |
| 22 | 60 | 220 | 5 | 400 | 2600 |
| 30 | 40 | 135 | 4 | 400 | 3600 |
| 36 | 34 | 110 | 4 | 400 | 4300 |
| 30s | 25 | 90 | 2,7 | 340 | 3600 |
| 52 | 12 | 40 | 2 | 340 | 6200 |

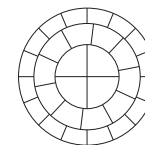

SPEZZATRICI ARROTONDATRICI SEMI AUTOMATICHE



*Semi automatic
bun rounding dividers
Diviseuses bouleuse
semi automatiques
Teigteil- und Wirkmaschine
Halbautomatisch
Divisoras boleadoras
semi automáticas
Тестоделители-округлители
Полуавтоматические*

| divisioni /divisions | grammatura /weight min | grammatura /weight max | capacità vasca / basin capacity | ø testata / head diamete | capacità oraria / hourly capacity |
|-------------------------|---------------------------|---------------------------|------------------------------------|-----------------------------|--------------------------------------|
| | gr | gr | kg | mm | pz./h |
| 11 | 180 | 500 | 5,5 | 400 | 1300 |
| 15 | 150 | 360 | 5,5 | 400 | 1800 |
| 18 | 120 | 280 | 5 | 400 | 2100 |
| 22 | 60 | 220 | 5 | 400 | 2600 |
| 30 | 40 | 135 | 4 | 400 | 3600 |
| 36 | 34 | 110 | 4 | 400 | 4300 |
| 30s | 25 | 90 | 2,7 | 340 | 3600 |
| 52 | 12 | 40 | 2 | 340 | 6200 |

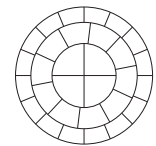



SPEZZATRICI ARROTONDATRICI MANUALI

Manual bun
rounding dividers
Teigteil- und
Wirkmaschine Manuell
Diviseurs
bouleuse manuelles
Divisoras boleadoras
manuales
Тестоделители-округлители
Ручные

| divisioni /divisions | grammatura /weight min | grammatura /weight max | capacità vasca / basin capacity | ø testata / head diamete | capacità oraria / hourly capacity |
|-------------------------|---------------------------|---------------------------|------------------------------------|-----------------------------|--------------------------------------|
| | gr | gr | kg | mm | pz./h |
| 11 | 180 | 500 | 5,5 | 400 | 1300 |
| 15 | 150 | 360 | 5,5 | 400 | 1800 |
| 18 | 120 | 280 | 5 | 400 | 2100 |
| 22 | 60 | 220 | 5 | 400 | 2600 |
| 30 | 40 | 135 | 4 | 400 | 3600 |
| 36 | 34 | 110 | 4 | 400 | 4300 |
| 30s | 25 | 90 | 2,7 | 340 | 3600 |
| 52 | 12 | 40 | 2 | 340 | 6200 |

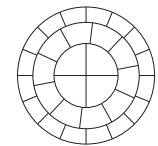

SCEGLI IL TUO TAGLIO

Pick your cut.





Mantenendo le stesse caratteristiche della macchina, offriamo la possibilità di abbinare 3 diversi tipi di taglio e di divisioni. Trovare la macchina ideale per il vostro lavoro non è mai stato così facile. Usarla non è mai stato così semplice.

Within the same model, we offer the possibility to combine three different types of cutting and shaping. Finding the ideal machine for your work has never been easier and using it has never been so simple.

Bei gleichbleibenden Maschineneigenschaften besteht die Möglichkeit, 3 unterschiedliche Form- und Unterteilungstypen zu kombinieren. Die ideale Maschine für Ihre Arbeit zu finden, war noch nie so einfach.



En conservant ses caractéristiques à la machine, nous offrons la possibilité d'associer 3 types différents de découpage et de divisions. Trouver la machine idéale pour votre travail n'a jamais été si facile.

Manteniendo las mismas características que la máquina, ofrecemos la posibilidad de combinar 3 tipos diferentes de corte y de divisiones. Encontrar la máquina ideal para su trabajo nunca ha sido tan fácil.

Сохраняя неизменными характеристики машины, мы предлагаем выбрать один из 3 видов разрезания и разделения. Найти идеальную машину для своей работы еще никогда не было так легко.



SPEZZATRICI E PRESSE AUTOMATICHE

*Automatic
dividers and presses
Teigteiler und Pressen
Automatisch*

*Diviseuses et presses
automatiques*

*Divisora y prensas
automáticas*

*Тестоделители и Прессы
Автоматические*

Vasca Rettangolare (H=125 mm)

Rectangular Basin

| divisioni /divisions | grammatura /weight min | grammatura /weight max | capacità vasca / basin capacity | pressino / press | capacità oraria / hourly capacity |
|-------------------------|---------------------------|---------------------------|------------------------------------|---------------------|--------------------------------------|
| | gr | gr | kg | mm | pz./h |
| 10 | 300 | 2000 | 20 | 100x200 | 1200 |
| 20 | 150 | 1000 | 20 | 100x100 | 2400 |
| 20s | 80 | 500 | 10 | 80x80 | 2400 |
| 24 | 130 | 830 | 20 | 100x80 | 2800 |
| 30 | 100 | 660 | 20 | 80x84 | 3600 |
| 40 | 80 | 500 | 20 | 50x100 | 4800 |
| 48 | 60 | 400 | 20 | 50x80 | 5700 |
| 60 | 50 | 330 | 20 | 80x42 | 7200 |
| 80 | 40 | 250 | 20 | 50x50 | 9600 |

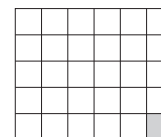

Vasca Rettangolare - pressa (H=135 mm)

Rectangular Basin

| divisioni /divisions | grammatura /weight min | grammatura /weight max | capacità vasca / basin capacity | vasca / basin | capacità oraria / hourly capacity |
|-------------------------|---------------------------|---------------------------|------------------------------------|------------------|--------------------------------------|
| | gr | gr | kg | mm | pz./h |
| unica/unique | - | - | 20 | 512x409 | 120 |



Vasca Rettangolare - doppio taglio (H=110 mm)

Rectangular - double cut Basin

| divisioni /divisions | | grammatura /weight min | grammatura /weight max | capacità vasca / basin capacity | pressino / press | capacità oraria / hourly capacity |
|-------------------------|----|---------------------------|---------------------------|------------------------------------|---------------------|--------------------------------------|
| | | gr | gr | kg | mm | pz./h |
| 10/20 | 10 | 300 | 1800 | 18 | 100x200 | 1200 |
| | 20 | 150 | 900 | 18 | 100x100 | 2400 |
| 12/24 | 12 | 260 | 1500 | 18 | 80x200 | 1400 |
| | 24 | 130 | 750 | 18 | 80x100 | 2800 |
| 15/30 | 15 | 200 | 1200 | 18 | 80x170 | 1800 |
| | 30 | 100 | 600 | 18 | 80x84 | 3600 |

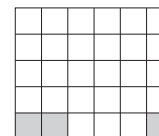

Vasca Rotonda (H=125 mm)

Round Basin

| divisioni /divisions | grammatura /weight min | grammatura /weight max | capacità vasca / basin capacity | pressino / press | capacità oraria / hourly capacity |
|-------------------------|---------------------------|---------------------------|------------------------------------|---------------------|--------------------------------------|
| | gr | gr | kg | mm | pz./h |
| 16 | 190 | 1200 | 20 | - | 1900 |
| 20 | 150 | 1000 | 20 | - | 2400 |
| 24 | 130 | 830 | 20 | - | 2800 |

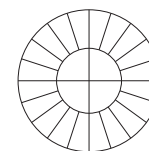

Vasca Esagonale (H=110 mm)

Hexagonal Basin

| divisioni /divisions | grammatura /weight min | grammatura /weight max | capacità vasca / basin capacity | pressino / press | capacità oraria / hourly capacity |
|-------------------------|---------------------------|---------------------------|------------------------------------|---------------------|--------------------------------------|
| | gr | gr | kg | mm | pz./h |
| 19 | 90 | 500 | 9,5 | 85 | 2300 |
| 37 | 30 | 160 | 6 | 57 | 4400 |
| 37 | 45 | 220 | 8 | 65 | 4400 |

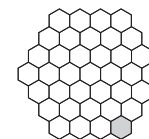



SPEZZATRICI E PRESSE SEMIAUTOMATICHE

*Semi automatic
dividers and presses
Teigteiler und Pressen
Halbautomatisch*

*Diviseuses et presses
semi automatiques*

*Divisora y prensas
semi automatiche*

*Тестоделители и Прессы
Полуавтоматические*

Vasca Rettangolare (H=125 mm) Rectangular Basin

| divisioni /divisions | grammatura /weight min | grammatura /weight max | capacità vasca / basin capacity | pressino / press | capacità oraria / hourly capacity |
|-------------------------|---------------------------|---------------------------|------------------------------------|---------------------|--------------------------------------|
| | gr | gr | kg | mm | pz./h |
| 10 | 300 | 2000 | 20 | 100x200 | 1200 |
| 20 | 150 | 1000 | 20 | 100x100 | 2400 |
| 20s | 80 | 500 | 10 | 80x80 | 2400 |
| 24 | 130 | 830 | 20 | 100x80 | 2800 |
| 30 | 100 | 660 | 20 | 80x84 | 3600 |
| 40 | 80 | 500 | 20 | 50x100 | 4800 |
| 48 | 60 | 400 | 20 | 50x80 | 5700 |
| 60 | 50 | 330 | 20 | 80x42 | 7200 |
| 80 | 40 | 250 | 20 | 50x50 | 9600 |

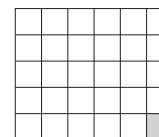

Vasca Rettangolare - pressa (H=135 mm)

Rectangular Basin

| divisioni / divisions | grammatura / weight min | grammatura / weight max | capacità vasca / basin capacity | vasca / basin | capacità oraria / hourly capacity |
|-----------------------|-------------------------|-------------------------|---------------------------------|---------------|-----------------------------------|
| | gr | gr | kg | mm | pz./h |
| unica/unique | - | - | 20 | 512x409 | 120 |

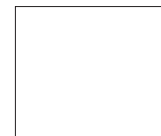

Vasca Rettangolare - doppio taglio (H=110 mm)

Rectangular - double cut Basin

| divisioni / divisions | | grammatura / weight min | grammatura / weight max | capacità vasca / basin capacity | pressino / press | capacità oraria / hourly capacity |
|-----------------------|----|-------------------------|-------------------------|---------------------------------|------------------|-----------------------------------|
| | | gr | gr | kg | mm | pz./h |
| 10/20 | 10 | 300 | 1800 | 18 | 100x200 | 1200 |
| | 20 | 150 | 900 | 18 | 100x100 | 2400 |
| 12/24 | 12 | 260 | 1500 | 18 | 80x200 | 1400 |
| | 24 | 130 | 750 | 18 | 80x100 | 2800 |
| 15/30 | 15 | 200 | 1200 | 18 | 80x170 | 1800 |
| | 30 | 100 | 600 | 18 | 80x84 | 3600 |

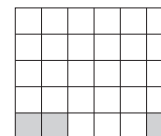

Vasca Rotonda (H=125 mm)

Round Basin

| divisioni / divisions | grammatura / weight min | grammatura / weight max | capacità vasca / basin capacity | pressino / press | capacità oraria / hourly capacity |
|-----------------------|-------------------------|-------------------------|---------------------------------|------------------|-----------------------------------|
| | gr | gr | kg | mm | pz./h |
| 16 | 190 | 1200 | 20 | - | 1900 |
| 20 | 150 | 1000 | 20 | - | 2400 |
| 24 | 130 | 830 | 20 | - | 2800 |

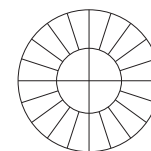

Vasca Esagonale (H=110 mm)

Hexagonal Basin

| divisioni / divisions | grammatura / weight min | grammatura / weight max | capacità vasca / basin capacity | pressino / press | capacità oraria / hourly capacity |
|-----------------------|-------------------------|-------------------------|---------------------------------|------------------|-----------------------------------|
| | gr | gr | kg | mm | pz./h |
| 19 | 90 | 500 | 9,5 | 85 | 2300 |
| 37 | 30 | 160 | 6 | 57 | 4400 |
| 37 | 45 | 220 | 8 | 65 | 4400 |

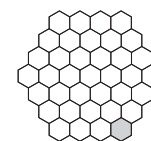



SPEZZATRICI MANUALI

Manual dividers
Diviseuses manuelles
Teigteiler Manuell
Divisora manuales
Тестоделители Ручные

Vasca Rettangolare (H=70 mm) - SQ M

Rectangular Basin

| divisioni /divisions | grammatura /weight min | grammatura /weight max | capacità vasca / basin capacity | pressino / press | capacità oraria / hourly capacity |
|-------------------------|---------------------------|---------------------------|------------------------------------|---------------------|--------------------------------------|
| | gr | gr | kg | mm | pz./h |
| 20 | 80 | 350 | 7 | 80x80 | 1200 |
| 42 | 40 | 170 | 7 | 57x53 | 1200 |

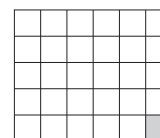

Vasca Rotonda (H=70 mm) - ST M

Round Basin

| divisioni /divisions | grammatura /weight min | grammatura /weight max | capacità vasca / basin capacity | pressino / press | capacità oraria / hourly capacity |
|-------------------------|---------------------------|---------------------------|------------------------------------|---------------------|--------------------------------------|
| | gr | gr | kg | mm | pz./h |
| 20 | 150 | 550 | 11 | - | 1200 |

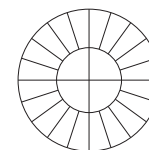

Vasca Esagonale (H=70 mm) - SE M

Hexagonal Basin

| divisioni /divisions | grammatura /weight min | grammatura /weight max | capacità vasca / basin capacity | pressino / press | capacità oraria / hourly capacity |
|-------------------------|---------------------------|---------------------------|------------------------------------|---------------------|--------------------------------------|
| | gr | gr | kg | mm | pz./h |
| 19 | 90 | 300 | 6 | 85 | 1200 |
| 37 | 30 | 130 | 5 | 57 | 2200 |
| 37 | 45 | 160 | 6 | 65 | 2200 |

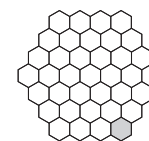

PERSONALIZZAZIONI

*Create your divider
and enjoy it.*

VISIT OUR WEBSITE VITELLASRL.COM



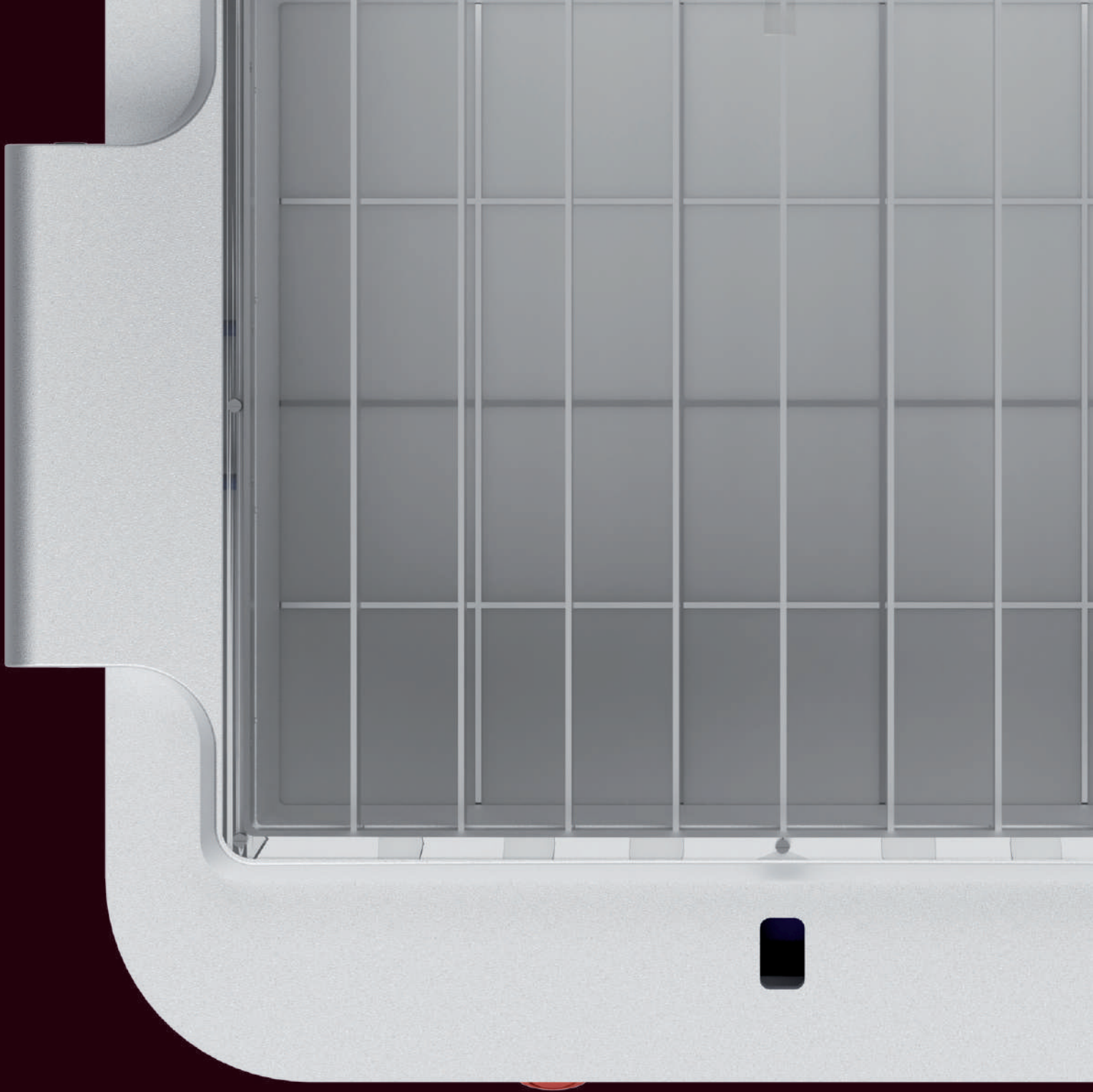



ACCESSORI E OPTIONAL

Accessories and optionals

Con una serie di accessori, vi diamo la possibilità di personalizzare la vostra macchina al meglio. Potrete così creare una macchina che soddisfi tutte le vostre esigenze per quanto riguarda sicurezza, qualità, pulizia e praticità.

With a range of accessories, we give you the ability to customize your machine to the fullest. So you can create a machine that meets all your requirements with regard to safety, quality, cleanliness and convenience.

Mit einer Reihe von Zubehör bieten wir Ihnen die Möglichkeit, Ihre Maschine individuell zu gestalten. So können Sie eine Maschine zusammenstellen, die in Sachen Sicherheit, Qualität, Sauberkeit und Zweckmäßigkeit Ihren Ansprüchen gerecht wird.

Avec une série d'accessoires, nous vous donnons la possibilité de personnaliser votre machine au mieux. Vous pourrez ainsi créer une machine qui satisfait toutes vos exigences en ce qui concerne sécurité, qualité, propreté et commodité.

Con una serie de accesorios, ofrecemos la posibilidad de personalizar la máquina de la mejor manera. Así se puede crear una máquina que satisfaga todas sus necesidades en lo que se refiere a seguridad, calidad, limpieza y practicidad.

Предлагаемые нами принадлежности позволят вам оснастить свою машину согласно своим индивидуальным нуждам. Благодаря чему вы можете создать машину, которая удовлетворяет все ваши потребности в области безопасности, качества, чистоты и практичности.

GRIGLIA E PORTAGRIGLIA

Grids and grid holder

Con un sistema pratico e veloce, che non rovinerà le caratteristiche del prodotto, si possono applicare ad esso vari tipi di griglie, dando così la possibilità di avere molteplici tipi di taglio con la stessa macchina.

Each divider can be equipped with various types of grids to expand its capabilities. Vitella's quick and efficient system of changeable grids is designed to achieve the cuts, sizing and shapes best suited for each type of dough, while using the same machine.

Mit einem praktischen und schnellen System, das die Produkteigenschaften nicht beeinträchtigt, können verschiedene Formgitter verwendet werden, wodurch mit ein und derselben Maschine zahlreiche Teilungsmöglichkeiten bestehen.

Avec un système pratique et rapide, qui n'altérera pas les caractéristiques du produit, on peut appliquer à celui-ci différents types de grilles, ce qui donne la possibilité d'avoir de multiples types de découpage avec la même machine.

Con un sistema práctico y rápido, que no dañará las características del producto, se pueden aplicar a este varios tipos de rejillas; de esta manera se ofrece la posibilidad de tener múltiples tipos de corte con la misma máquina.

Практичная и быстрая система, которая не нарушает характеристик изделия, позволяет установить различные типы решеток, чтобы осуществлять различные виды резки на одной машине.





GRIGLIE PER SPEZZATRICI E PRESSE

Grids for SQ-PB

Griglia / Grid
4 Divisioni / Div.
Pz. singolo / Single pcs.
254x202 mm

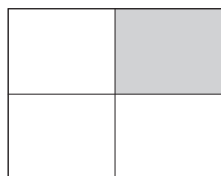

Griglia / Grid
5 Divisioni / Div.
Pz. singolo / Single pcs.
100x400 mm

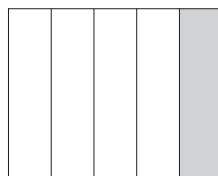

Griglia / Grid
6 Divisioni / Div.
Pz. singolo / Single pcs.
85x400 mm

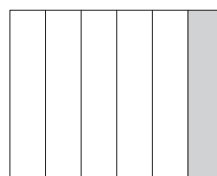

Griglia / Grid
7 Divisioni / Div.
Pz. singolo / Single pcs.
70x400 mm

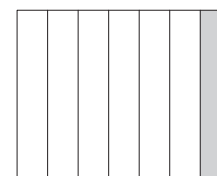

Griglia / Grid
8 Divisioni / Div.
Pz. singolo / Single pcs.
250x100 mm

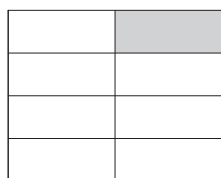

Griglia / Grid
8 Divisioni / Div.
Pz. singolo / Single pcs.
50x512 mm

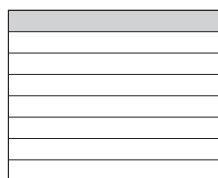

Griglia / Grid
10 Divisioni / Div.
Pz. singolo / Single pcs.
100x200 mm

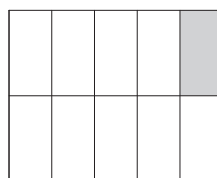

Griglia / Grid
10 Divisioni / Div.
Pz. singolo / Single pcs.
50x400 mm

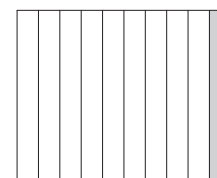

Griglia / Grid
14 Divisioni / Div.
Pz. singolo / Single pcs.
70x200 mm

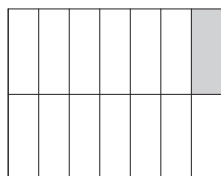

Griglia / Grid
15 Divisioni / Div.
Pz. singolo / Single pcs.
170x80 mm

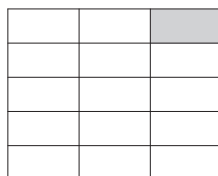

Griglia / Grid
15 Divisioni / Div.
Pz. singolo / Single pcs.
30x400 mm

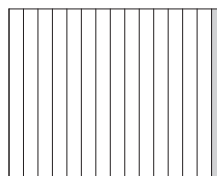

Griglia / Grid
16 Divisioni / Div.
Pz. singolo / Single pcs.
125x100 mm

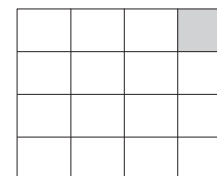

Griglia / Grid
20 Divisioni / Div.
Pz. singolo / Single pcs.
50x200 mm

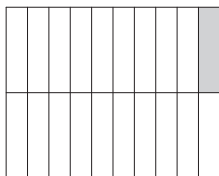

Griglia / Grid
20 Divisioni / Div.
Pz. singolo / Single pcs.
100x100 mm

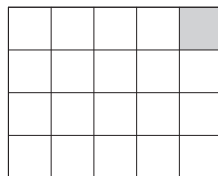

Griglia / Grid
24 Divisioni / Div.
Pz. singolo / Single pcs.
134x126x184 mm

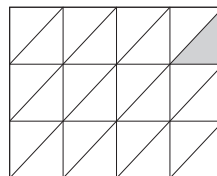

Griglia / Grid
24 Divisioni / Div.
Pz. singolo / Single pcs.
66x125 mm

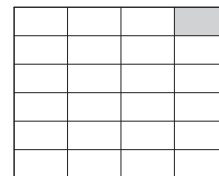

Griglia / Grid
28 Divisioni / Div.
Pz. singolo / Single pcs.
57x126 mm

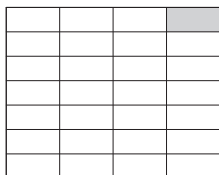

Griglia / Grid
30 Divisioni / Div.
Pz. singolo / Single pcs.
80x80 mm

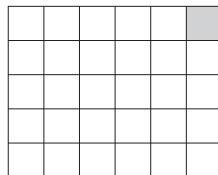

Griglia / Grid
36 Divisioni / Div.
Pz. singolo / Single pcs.
44x126 mm

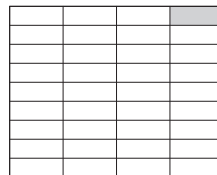

Griglia / Grid
40 Divisioni / Div.
Pz. singolo / Single pcs.
50x100 mm

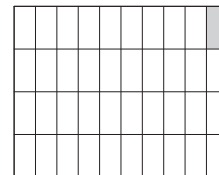

Griglia / Grid
40 Divisioni / Div.
Pz. singolo / Single pcs.
100x100x140 mm

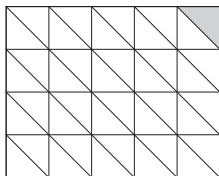

Griglia / Grid
64 Divisioni / Div.
Pz. singolo / Single pcs.
62x50 mm

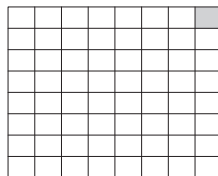

Griglia / Grid
80 Divisioni / Div.
Pz. singolo / Single pcs.
50x50 mm

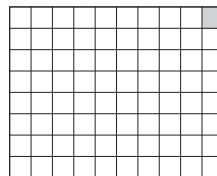

Possibilità
di personalizzazioni
/ Customizability



CARTER LATERALI

Side Panels

Per chi vuole poter pulire la spezzatrice in maniera accurata al suo interno, diamo la possibilità di aggiungere altre due porte apribili dai lati, in modo da facilitare l'operatore nelle pulizie periodiche della macchina.

For those who want to accurately clean the divider inside and out, two or more removable doors can be added. Opening from the sides, they facilitate the operator with the routine cleaning of the machine.

Wenn das Innere des Teigteilers einer gründlichen Reinigung unterzogen werden soll, kann er mit zwei zusätzlichen abnehmbaren Seitentüren ausgestattet werden, welche die regelmäßigen Reinigungsarbeiten an der Maschine erleichtern.

Pour ceux qui veulent pouvoir nettoyer l'intérieur de la diviseuse minutieusement, nous donnons la possibilité d'ajouter deux autres portes ouvrables par le côté, de façon à aider l'opérateur lors des nettoyages périodiques de la machine.

Para quien quiere limpiar el interior de la porcionadora de una manera precisa, ofrecemos la posibilidad de añadir dos puertas que se pueden abrir por los lados, de manera que el operador puede realizar fácilmente la limpieza periódica de la máquina.

При желании обеспечить возможность тщательной чистки внутренней части тестоделительной машины, мы предлагаем установить две дополнительные боковые двери, чтобы облегчить оператору осуществление периодической чистки машины.



REGOLATORE DI PRESSIONE E GUARNIZIONE COPERCHIO

Pressure Regulators and Seal Covers

Il regolatore di pressione ti permette di avere due tipi di pressione nella fase di pressatura. Il vantaggio è che con paste molto idratate, diminuendo la pressione, non si andrà a rovinare le caratteristiche del prodotto perché, premendo dolcemente sull'impasto, non andiamo a sgararlo.

La guarnizione coperchio è un sistema che, durante tutto il ciclo di lavoro della macchina, permette di limitare la fuoriuscita dalla vasca delle polveri di farina rendendo l'ambiente circostante più sano.

A pressure regulator lets the operator choose between two types of pressure during the pressing phase. The advantage of a gentler handling for very hydrated doughs is the optimal preservation of the characteristics of the product, thus avoiding ruinous deflations. Seal Covers is a feature that, while the machine is in operation, greatly limits the diffusion of flour from the tub, resulting in a healthier workplace.

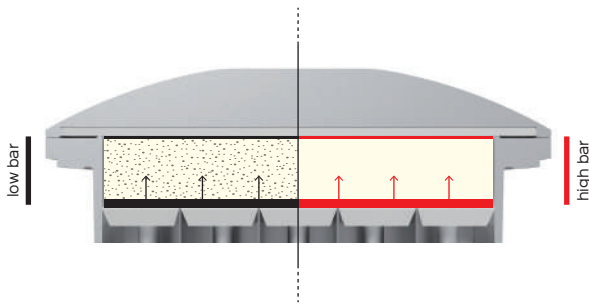

Mit dem Druckregler stehen beim Pressen zwei Druckstärken zur Verfügung. Der Vorteil ist, dass die Produkteigenschaften besonders feuchter Teige durch eine Druckverringerung nicht beeinträchtigt werden, da ein sanfter Druck den Teig nicht entgast.

Die Deckeldichtung ist ein Dabei handelt sich um ein System, mit dem sich während des gesamten Arbeitszyklus der Maschine das Austreten von Mehlstaub aus der Wanne reduzieren lässt, und das so für eine gesündere Umgebung sorgt.

Le régulateur de pression vous permet d'avoir deux types de pression lors de la phase de pressage. L'avantage est qu'avec des pâtes très hydratées, en diminuant la pression, on n'altérera pas les caractéristiques du produit parce que, en appuyant doucement sur la pâte, on n'enlève pas le gaz qu'elle contient. Le Garniture Du Couvercle c'est un système qui, durant tout le cycle de travail de la machine, permet de limiter la sortie des poussières de farine hors de la cuve ce qui rend le milieu environnant plus sain.

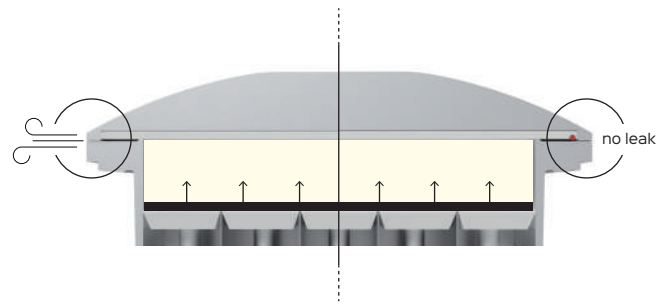

El regulador de presión permite tener dos tipos de presión en la fase de prensado. La ventaja es que para pastas con mucha agua, al disminuir la presión, no se dañan las características del producto ya que, al apretar suavemente la masa, no se elimina el gas.

La Guarnición de la Tapa es un sistema que, durante todo el ciclo de trabajo de la máquina, limita la salida de la cuba del polvo de harina y hace que el ambiente circundante sea más sano.

ляет использовать два уровня давления во время прессования. Преимущество заключается в том, что в тесте с большим содержанием влаги при уменьшении давления не нарушаются характеристики изделия, поскольку при легком сдавливании теста из него не выдавливаются пузырьки газа.

Прокладка Крышки Эта система позволяет на протяжении всего рабочего цикла машины ограничивать утечку муки из дежи, делая окружающую среду более здоровой.

DIMENSIONI E PESI

Dimensions and weights



Spezzatrici Arrotondatrici Automatiche
/ *Automatic bun rounding dividers*
Peso/Weight 245 Kg

DIMENSIONI IMBALLI/PACKING DIMENSIONS
760x1670x730 mm



Spezzatrici Arrotondatrici Semiautomatiche
/ *Semi automatic bun rounding dividers*
Peso/Weight 245 Kg

DIMENSIONI IMBALLI/PACKING DIMENSIONS
760x1670x730 mm

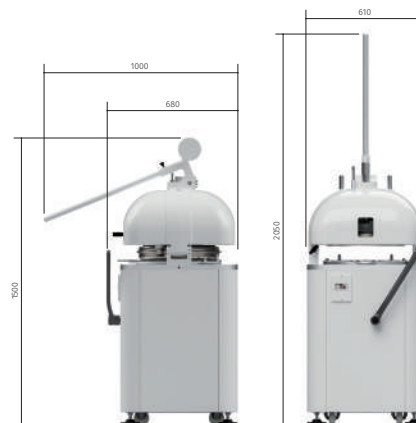

Spezzatrici Arrotondatrici Manuali
/ *Manual bun rounding dividers*
Peso/Weight 180 Kg

DIMENSIONI IMBALLI/PACKING DIMENSIONS
760x1670x730 mm

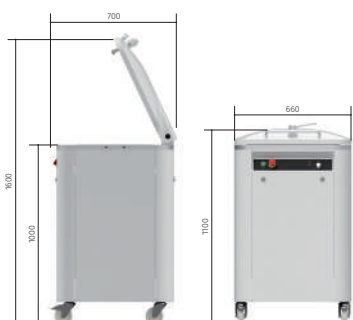

Spezzatrici e Presse Automatiche
/ *Automatic presses and dividers*
Peso/Weight 230 Kg

DIMENSIONI IMBALLI/PACKING DIMENSIONS
760x1360x730 mm

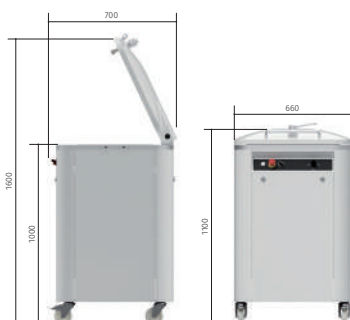

Spezzatrici e Presse Semiautomatiche
/ *Semi automatic presses and dividers*
Peso/Weight 230 Kg

DIMENSIONI IMBALLI/PACKING DIMENSIONS
760x1360x730 mm

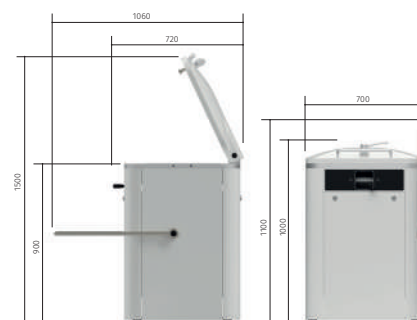

Spezzatrici Manuali
/ *Manual dividers*
Peso/Weight 180 Kg

DIMENSIONI IMBALLI/PACKING DIMENSIONS
760x1360x730 mm

INFORMAZIONI GENERALI

General information

Materiali utilizzati

Telaio in acciaio elettrosaldato verniciato;
Rivestimenti in acciaio verniciato o acciaio inox.
Vasche e testate in alluminio anticorodal MG5 con anodizzazione;
Cottelli e griglie in acciaio inox 304;
Superficie interna del coperchio e pressini in polietilene alimentare PE500;
Piatti in polietilene alimentare PETG;
Anello in alluminio con rivestimento in nichelatura chimica.

Alimentazione elettrica

Tutte le macchine vengono fornite standard con collegamento in 400 Volt 50 Hz 3 fasi. A richiesta, si possono fare con tensioni diverse.

Cura della macchina

Perché la macchina funzioni correttamente e soprattutto per la sua durata, consigliamo di fare una pulizia periodica, sia all'esterno che all'interno (vedi manuale d'uso). Gli acciai inox, i rivestimenti verniciati, il polietilene PE500 e i piatti in PETG si possono pulire semplicemente con acqua e sapone o detersivo neutro, poi bisogna risciacquare abbondantemente e asciugare con un panno morbido.

Matériaux utilisés

Châssis en acier électrosoudé peint ;
Revetements en acier peint ou en acier inox.
Cuves et têtes en aluminium anticorodal MG5 avec anodisation ;
Couteaux et grilles en acier inox 304 ;
Surface interne du capot et des taloches en polyéthylène alimentaire PE500 ;
Plateaux en polyéthylène alimentaire PETG ;
Bague en aluminium avec revêtement en nickelage chimique.

Alimentation électrique

Toutes les machines sont fournies dans la version standard avec alimentation à 400 V, 50 Hz, triphasée. Sur demande, elles peuvent être fournies avec des tensions différentes.

Entretien de la machine

Pour que la machine fonctionne correctement et surtout dure longtemps, nous conseillons de la nettoyer régulièrement aussi bien à l'extérieur qu'à l'intérieur (voir manuel d'instructions chapitre/paragraphe nettoyage). Les aciers inox, les revêtements peints, le polyéthylène PE500 et les plateaux en PETG peuvent être nettoyés simplement avec de l'eau et du savon ou un détergent neutre, qu'il faut ensuite rincer abondamment et essuyer avec un chiffon doux.

Materials Used

Frame in electro-welded, painted steel;
Coating in painted steel or stainless steel.
Basins in anticorodal aluminium MG5 with anodising;
Knives and grids in stainless steel 304;
Inner cover surface and presses in polyethylene for foodstuff use PE500;
Plates in polyethylene for foodstuff use PETG;
Ring in aluminium with chemical nickel-plating.

Electrical power supply

All machines are provided standard for an operating voltage of 400 Volt 50 Hz 3-phase. Other voltages can be provided on request.

Machine Care

To allow the machine to operate correctly and above all to ensure a long service life, we recommend regular cleaning, both inside and out (see operation manual, chapter/ paragraph on cleaning). The stainless steel parts, painted coatings, PE500 polyethylene and PETG plates can be cleaned simply using water and soap or a neutral detergent, then rinsed thoroughly and dried with a soft cloth.

Materiales utilizados

Armazón de acero electrosoldado pintado;
Revestimientos de acero barnizado o acero inoxidable.
Cubas y cabezales de aluminio anticorodal MG5 con anodización;
Cuchillos y rejillas de acero inoxidable 304;
Superficie interior de la tapa y dispositivos de presión de polietileno alimentario PE500;
Platos de polietileno alimentario PETG;
Anillo de aluminio con revestimiento en niquelado químico.

Alimentación eléctrica

Todas las máquinas se suministran de forma estándar con conexión de 400 voltios 50 Hz 3 fases. Bajo solicitud, se pueden suministrar con tensiones diferentes.

Cuidado de la máquina

Para que la máquina funcione correctamente y sobre todo para asegurar su duración, aconsejamos realizar una limpieza periódica, tanto del exterior como del interior (véase manual de uso). El acero inoxidable, los revestimientos barnizados, el polietileno PE500 y los platos de PETG se pueden limpiar simplemente con agua y jabón o detergente neutro, después es necesario enjuagar abundantemente y secar con un paño suave.

Verwendete Materialien

Lackierter verschweißter Stahlrahmen;
Verkleidungen aus lackiertem oder rostfreiem Stahl.
Wannen und Köpfe aus eloxiertem Aluminium Anticorodal MG5;
Messer und Gitter aus rostfreiem Stahl 304;
Deckelinnenfläche und Presser aus lebensmittelechtem Polyethylen PE500;
Platten aus lebensmittelechtem Polyethylen PETG;
Ring aus Aluminium mit chemischer Vernickelung.

Elektrischer Anschluss

Alle Maschinen werden mit einem Standardanschluss geliefert: Drehstrom 400 Volt 50 Hz. Auf Anfrage sind andere Spannungen möglich.

Pflege der Maschine

Damit ein reibungsloser Betrieb und vor allem eine lange Lebensdauer der Maschine gewährleistet ist, empfehlen wir, sie sowohl innen als auch außen regelmäßig zu reinigen (siehe Bedienungsanleitung). Der rostfreie Stahl, die lackierten Verkleidungen, das Polyethylen PE500 und die Platten aus PETG können einfach mit Wasser und Seife oder Neutralreiniger gereinigt und anschließend gründlich abgespült und mit einem weichen Tuch abtrocknet werden.

Используемые Материалы

Сварной каркас из окрашенной стали;
Облицовка из окрашенной стали или нержавеющей стали.
Дежи и головки из алюминиевого сплава антикородал MG5 с твердым анодированием;
Ножи и решетки из нержавеющей стали 304;
Внутренняя поверхность крышки и прессов из пищевого полиэтилена PE500;
Чашы из пищевого полиэтилена PETG;
Химически никелированное алюминиевое кольцо.

Электропитание

Все машины в стандартной комплектации поставляются с соединением 400 В, 50 Гц, 3 фазы. По требованию возможно изготовить машину для другого напряжения питания.

Уход За Машиной

Для обеспечения правильной работы и долговечности машины, рекомендуем ее периодически чистить, как снаружи, так и внутри (см. руководство по эксплуатации). Детали из нержавеющей стали, окрашенные поверхности, полиэтилен PE500 и чаши из PETG можно просто чистить водой с мылом или нейтральным моющим средством, после чего эти поверхности необходимо обильно прополоскать и вытереть досуха мягкой тканью.

N.B. le grammature min./max sono fornite a titolo puramente indicativo e possono variare a seconda del grado di lievitazione dei pastoni, sono indicative anche le produzioni orarie, perchè dipendono sempre dall' organizzazione interna dell' utilizzatore (test fatti in laboratorio attrezzato). / **N.B.** min./max. sizes are provided purely as an indication and can vary according to the degree of leavening of doughs; hourly production rates are also indicative, as they always depend on the user's internal organization (tests performed in a laboratory with equipment). / **N.B.** Die angegebenen min./max. Stückgrößen sind rein hinweisend und können je nach Aufgehgrad des Teigs variieren; als hinweisend gelten auch die genannten Stundenleistungen, da diese immer von der betriebsinternen Organisation des Benutzers abhängen (in Speziallabors durchgeführte Versuche). / **N.B.** les poids min./max. sont fournis à titre purement indicatif et peuvent varier suivant le degré de levage des pâtons. Il en va de même pour les productions horaires qui dépendent toujours de l'organisation interne de l' utilisateur (tests effectués dans un laboratoire équipé). / **Atención** los números mín./máx, de piezas se facilitan como indicación aproximada y pueden variar en función del grado de fermentación de las masas: también es indicativa la producción por hora ya que depende siempre de la organización interna del usuario (los ensayos han sido realizados en un taller equipado). / **Примечание** мин./макс. порции указываются исключительно в качестве примера и могут варьировать в зависимости от степени подъема дрожжевого теста. В качестве примера указаны так же значения почасовой производительности, т.к. она всегда зависит от организации производства пользователя (испытания проведены в оборудованной лаборатории).



Tutte le macchine sono conformi alle normative CE e sono prodotte in Italia / All machines are in conformity with EC regulations and are manufactured in Italy.

Riproduzione vietata. Le illustrazioni e i dati tecnici in questo catalogo si intendono a titolo indicativo e non sono vincolanti. La VITELLA si riserva il diritto di modificare, senza preavviso, i dati tecnici e le caratteristiche dei prodotti in qualsiasi momento al solo scopo di migliorarne le caratteristiche. / Reproduction prohibited. Pictures, explanations and technical details of this catalogue are supplied in indicative purpose and without any time bond. Consequently VITELLA has the right to make changes, without notice, for the sake of improving the products or for any constructive or commercial requirement.



vitella srl · bakery and pastry equipment
36015 Schio (VI) ITALIA - Vicolo Puglia 5/7/9
tel. +39 0445 575262 - fax +39 0445 501605
sales@vitellasrl.com - www.vitellasrl.com

A solid red circle is centered on the page. Inside the circle, the text "VITELLASRL.COM" is written in white, uppercase letters.

VITELLASRL.COM